



Main

Range of product	Magelis STO & STU
Product or component type	Touch panel screen
Software designation	Vijeo Designer
Operating system	Magelis
Processor name	CPU RISC

Complementary

Display size	3.4 inch
Display type	Backlit monochrome STN LCD
Background colour	Green, orange and red
Display resolution	200 x 80 pixels
Touch panel	Analogue
Backlight lifespan	10000 hours with red 50000 hours with orange 50000 hours with green
Brightness	8 levels
Contrast	16 levels via touch panel
Character font	Korean Taiwanese (traditional Chinese) Chinese (simplified Chinese) ASCII Japanese (ANK, Kanji)
[Us] rated supply voltage	24 V DC +/- 20 %
Inrush current	30 A
Local signalling	1 LED with green for normal operation
Power consumption in W	5 W
Number of pages	Limited by internal memory capacity
Processor frequency	333 MHz
Memory description	Application memory, 16 MB Back up of data, 128 kB
Integrated connection type	1 USB 2.0 type mini B 1 USB 2.0 type A Removable screw terminal block connector power supply Female RJ45 connector COM1 serial link with RS232C/RS485 interface at <= 115.2 kbits/s

Disclaimer: This documentation is not intended as a substitute for and is not to be used for determining suitability or reliability of these products for specific user applications

Supply	External source
Realtime clock	Access to the PLC real-time clock
Downloadable protocols	Modbus Third party protocols Uni-TE
Fixing mode	By 2 spring clips on 1.6...5 mm thick panel
Enclosure material	PPT
Marking	CE
Height	3.05 in (77.5 mm)
Width	4.59 in (116.5 mm)
Depth	1.44 in (36.5 mm)

Environment

Immunity to microbreaks	3 ms
Standards	EN 61131-2 FCC Class A UL 508 IEC 61000-6-2 UL 1604
Product certifications	UL Class 1 Division 2 T5 GOST UL Class 1 Division 2 T4A C-Tick CE cULus
Ambient air temperature for operation	32...122 °F (0...50 °C)
Ambient air temperature for storage	-4...140 °F (-20...60 °C)
Relative humidity	0...90 % without condensation
Operating altitude	<= 6561.68 ft (2000 m)
IP degree of protection	IP20 (rear panel) conforming to IEC 60529 IP65 (front panel) conforming to IEC 60529
NEMA degree of protection	NEMA 4X front panel (indoor use)
Shock resistance	15 gn 11 ms conforming to IEC 60068-2-27
Vibration resistance	+/- 3.5 mm (f = 5...9 Hz) conforming to IEC 60068-2-6 1 gn (f = 9...150 Hz) conforming to IEC 60068-2-6
Electromagnetic compatibility	Resistance to radiated electromagnetic fields : 10 V/m conforming to IEC 61000-4-3

Offer Sustainability

RoHS (date code: YYWW)	Compliant - since 1010 - Schneider Electric declaration of conformity Schneider Electric declaration of conformity
REACH	Reference not containing SVHC above the threshold Reference not containing SVHC above the threshold

Contractual warranty

Warranty period	18 months
-----------------	-----------

Dimensions with Spring Clips

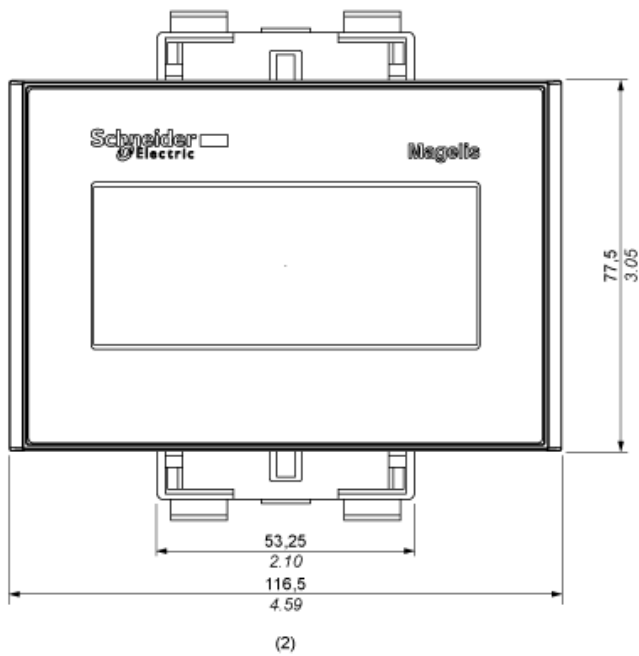
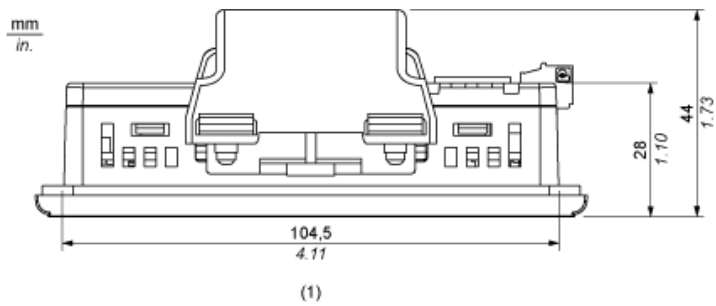

- (1) Top
- (2) Front

Dimensions without Spring Clips

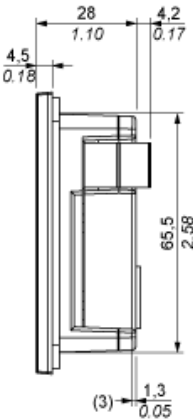
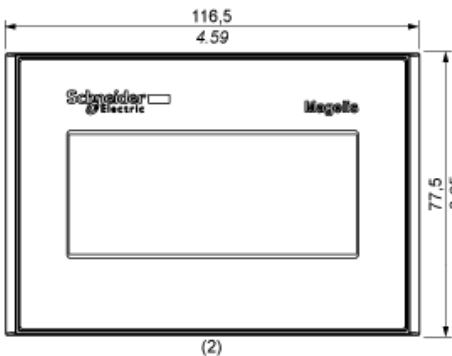
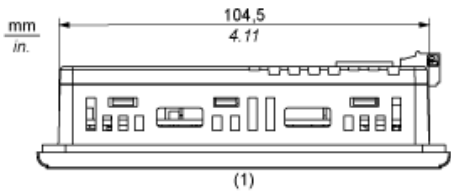

- (1) Top
- (2) Front
- (3) Right Side

Clearance

$\frac{\text{mm}}{\text{in.}}$

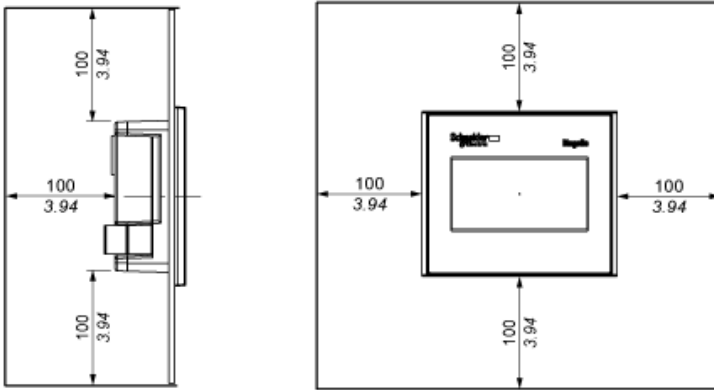

Panel Cut-out Dimensions

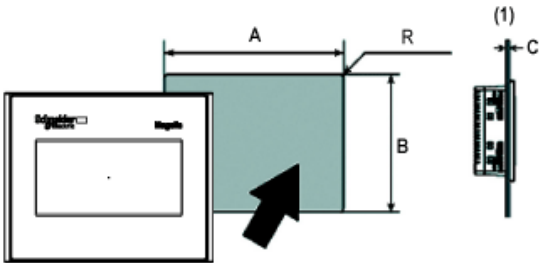

(1) Panel

A (mm)	A (in.)	B (mm)	B (in.)	C (mm) Spring Clips	C (in.) Spring Clips	R (mm)	R (in.)
+1	+0.04	+1	+0.04	1.5 to 6.0	0.059 to 0.236	2.0 to 3.0	0.078 to 0.118
105	4.13	66	2.59				
-0	-0	-0	-0				